

A-A

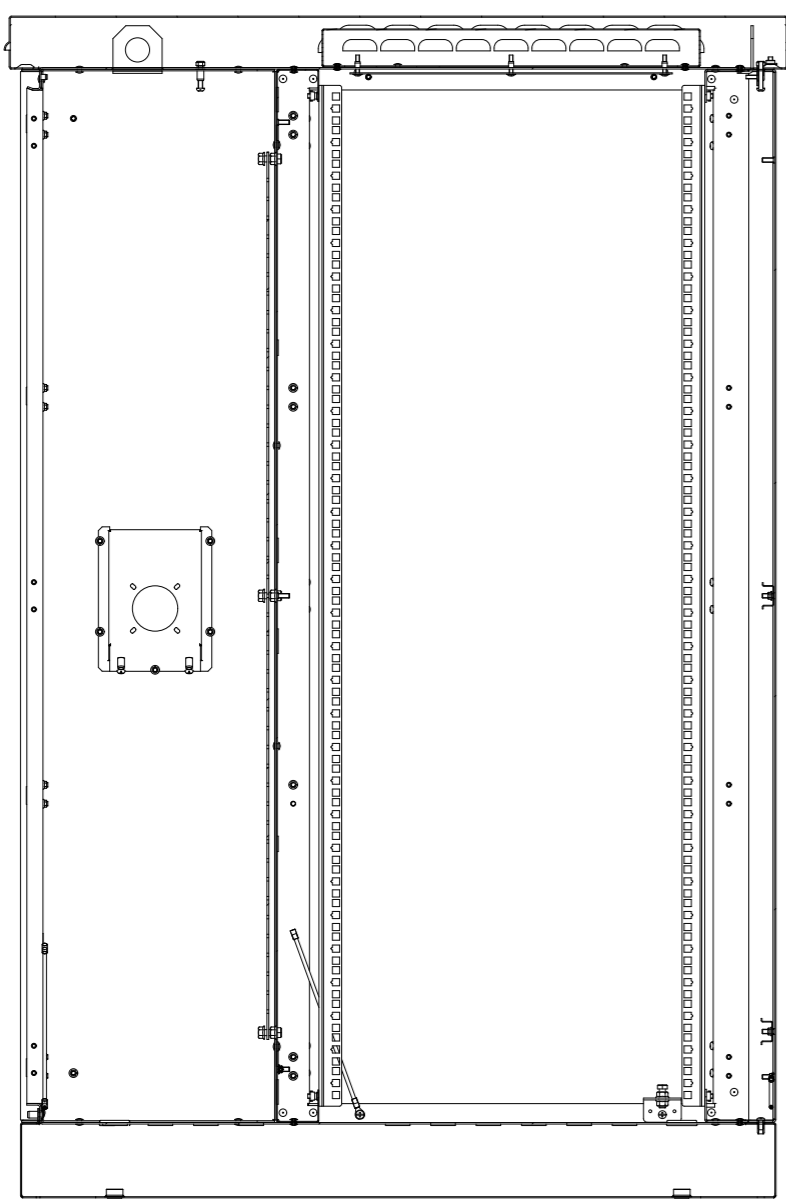

A-A

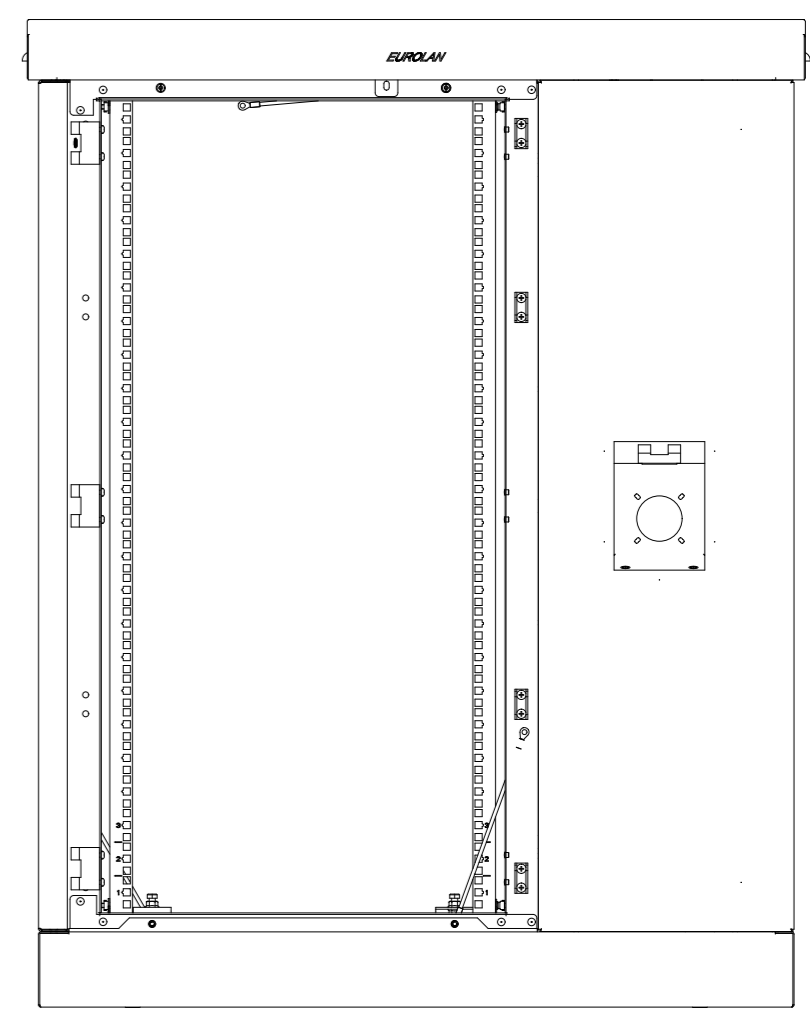
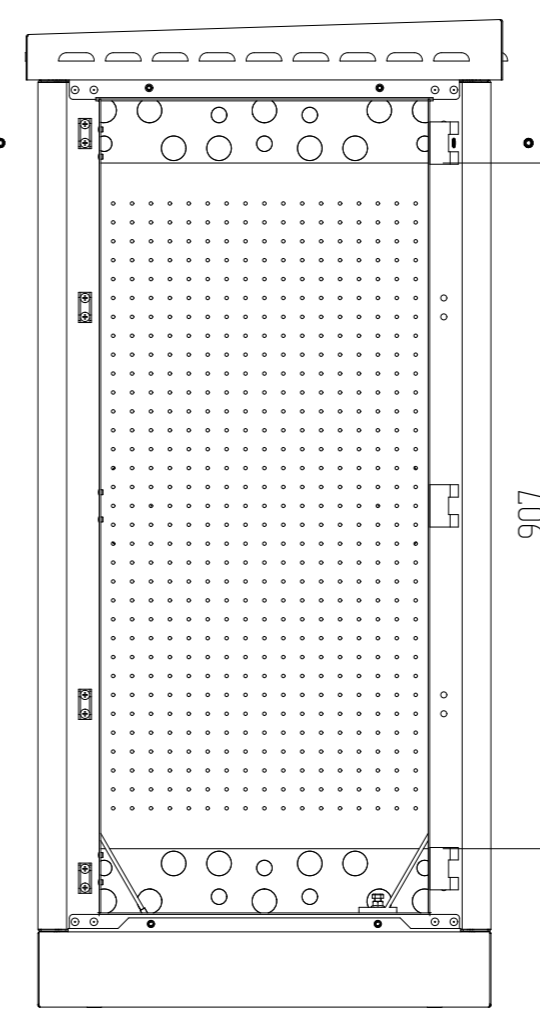
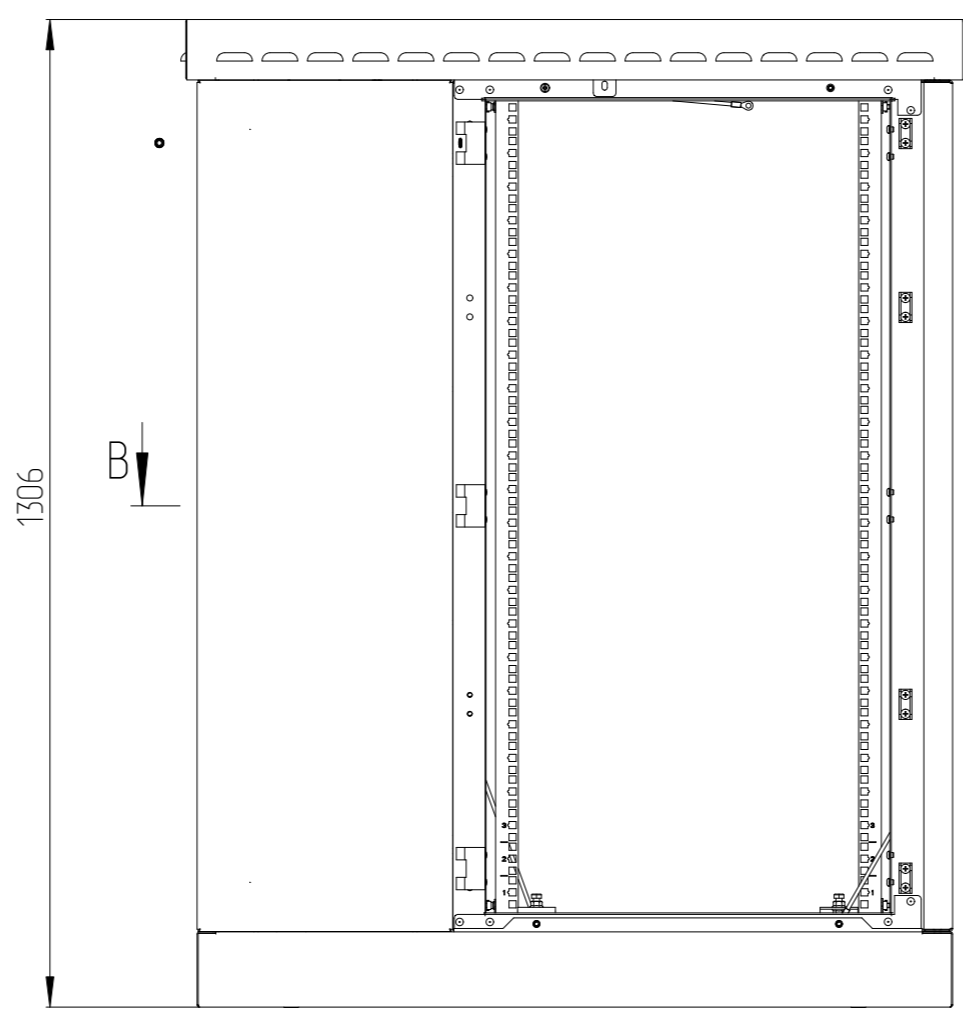
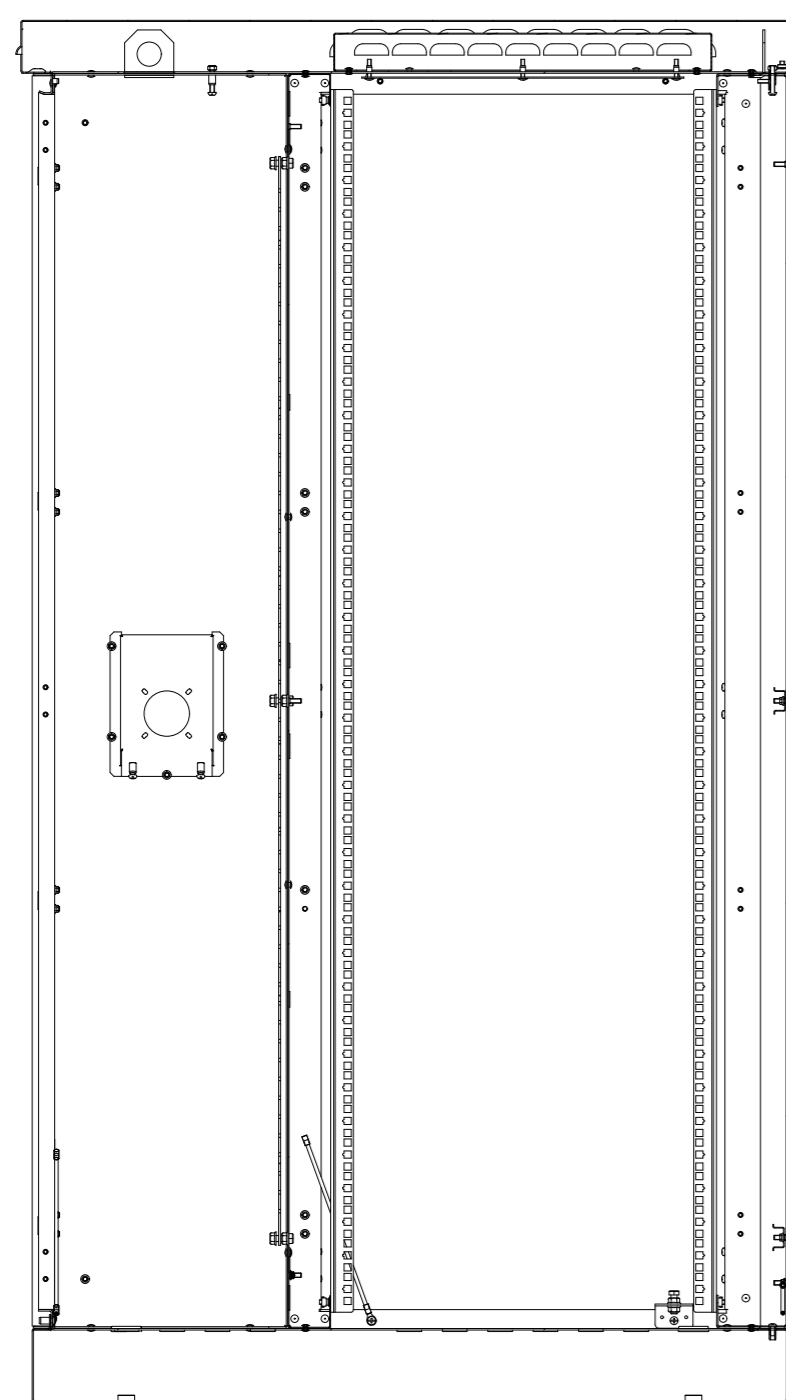
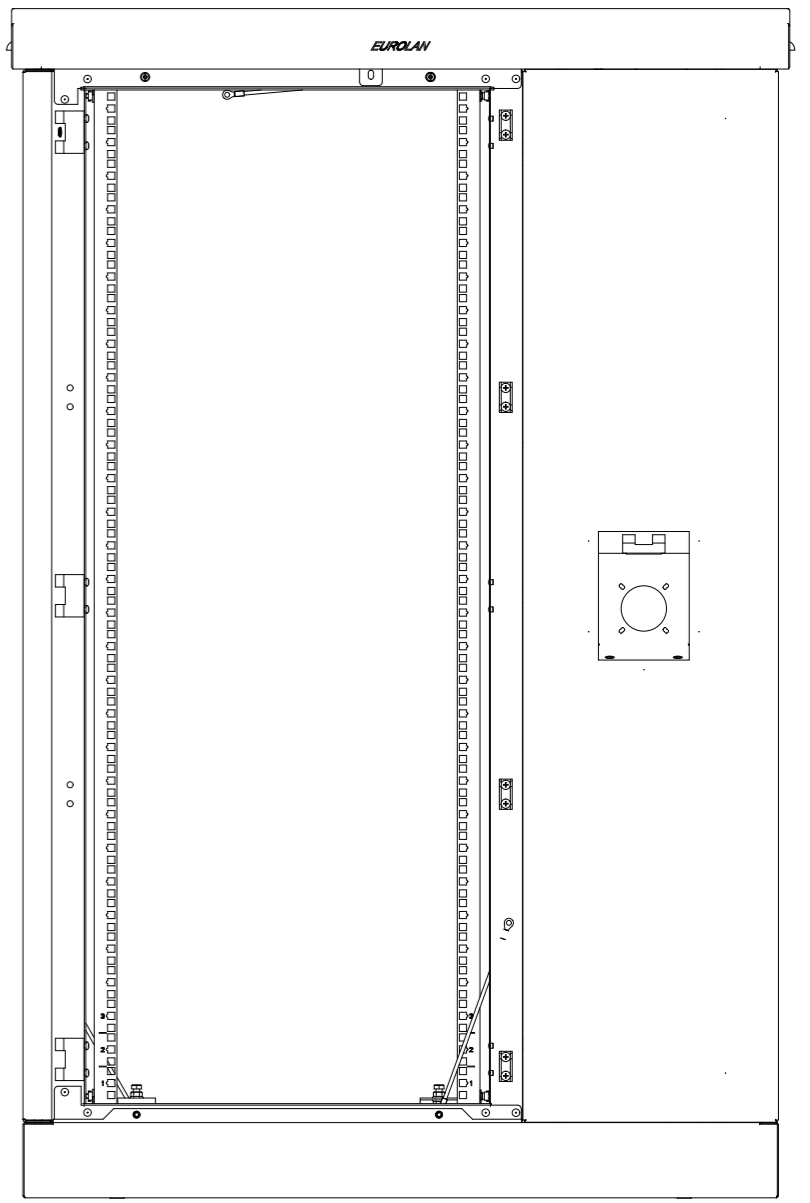
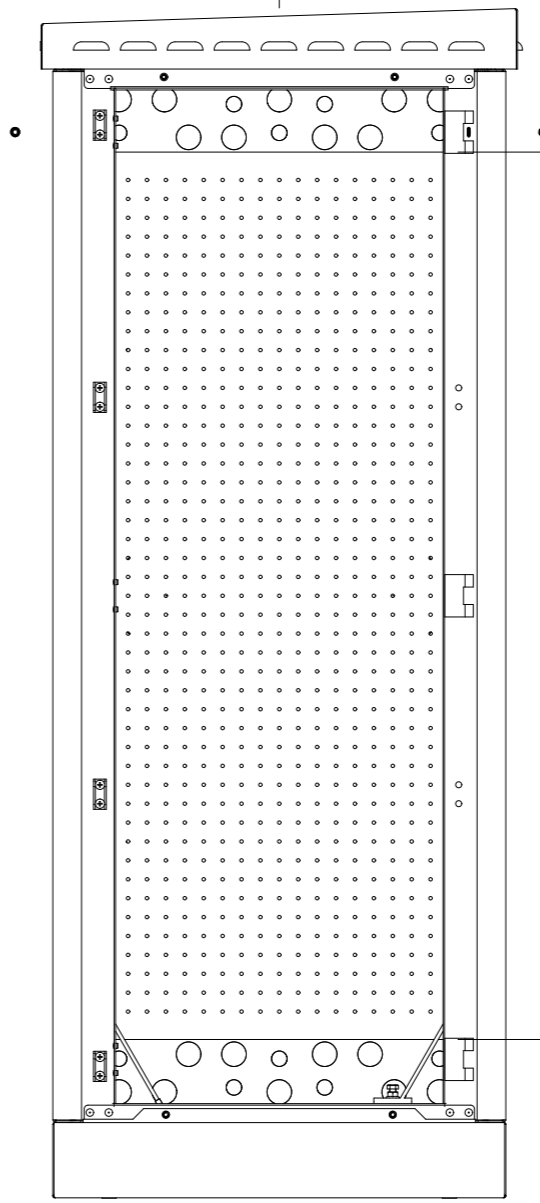
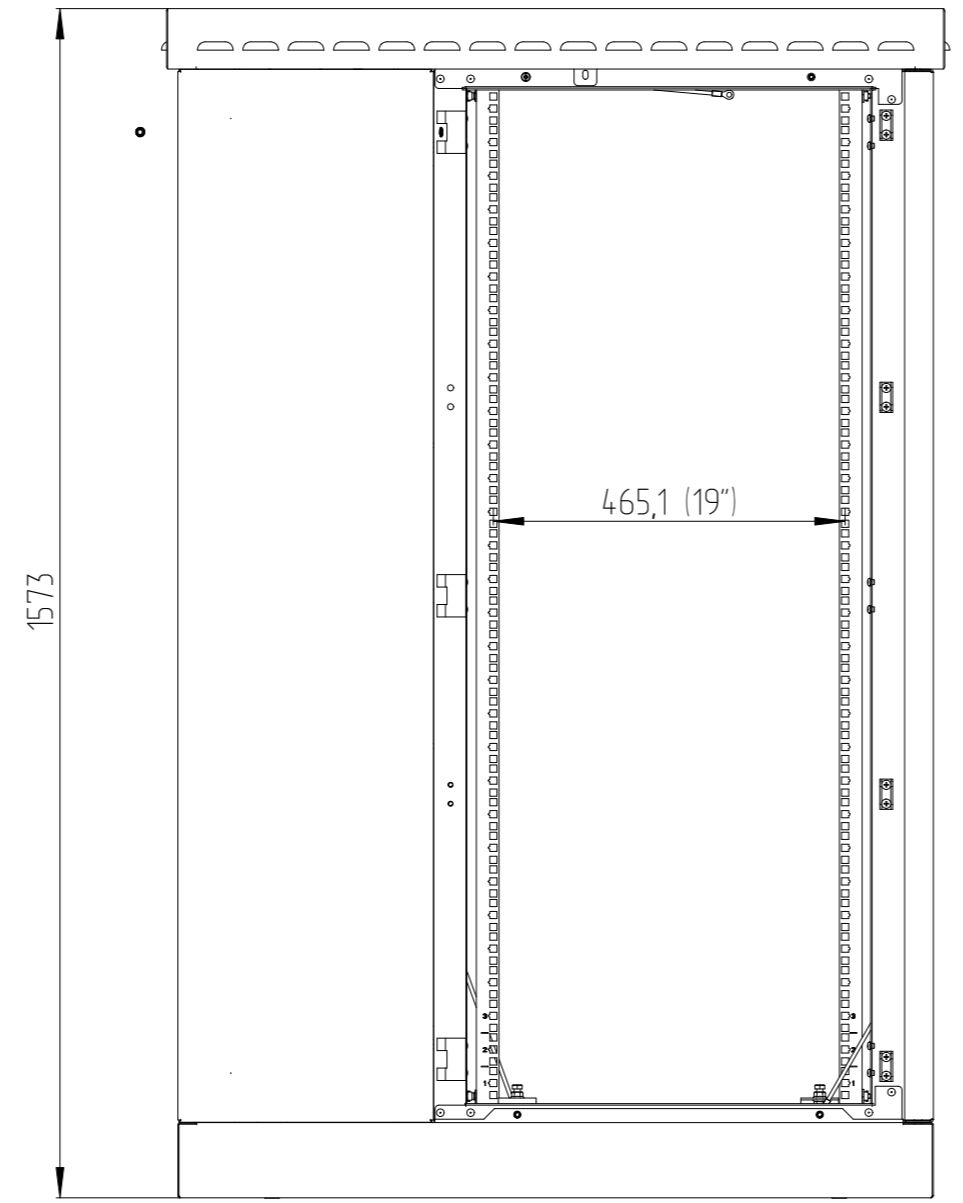

A-A

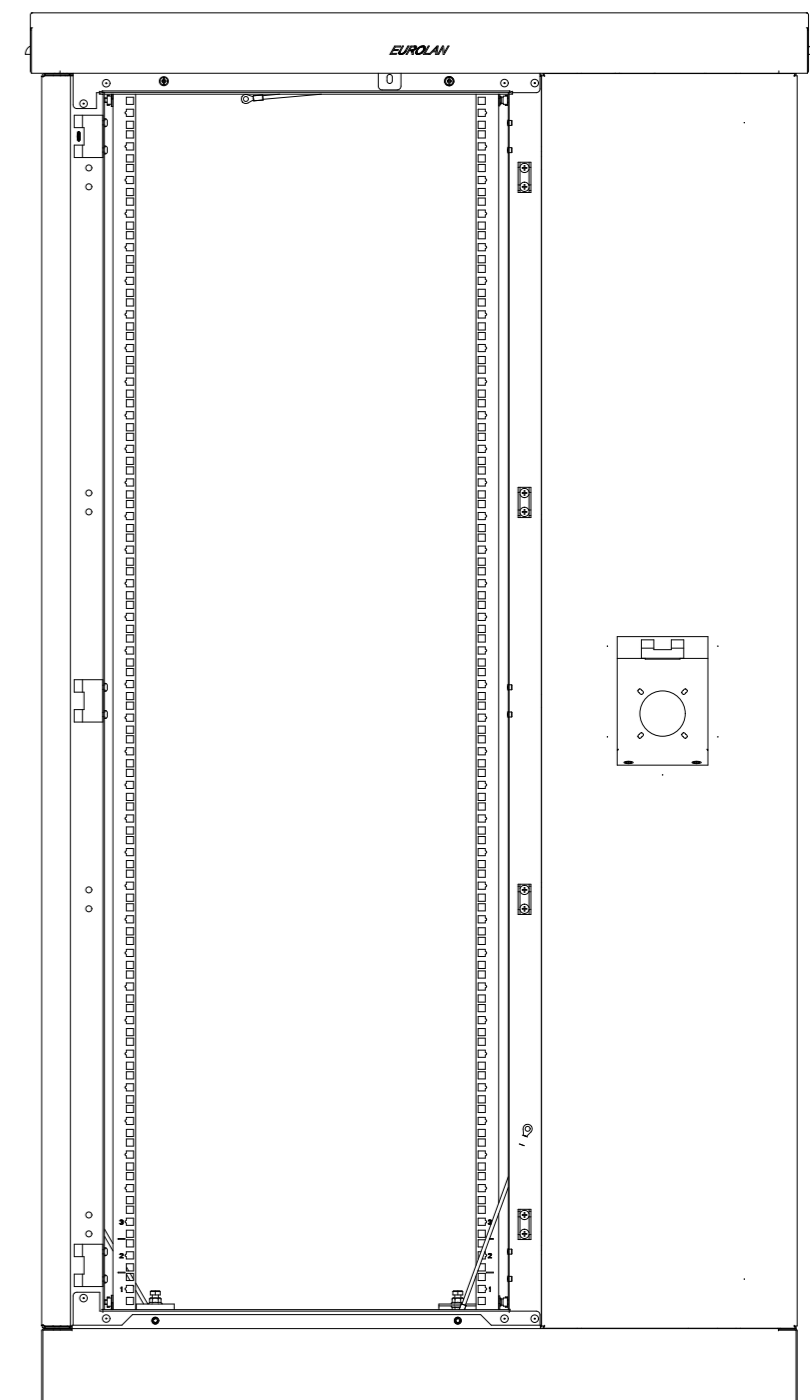
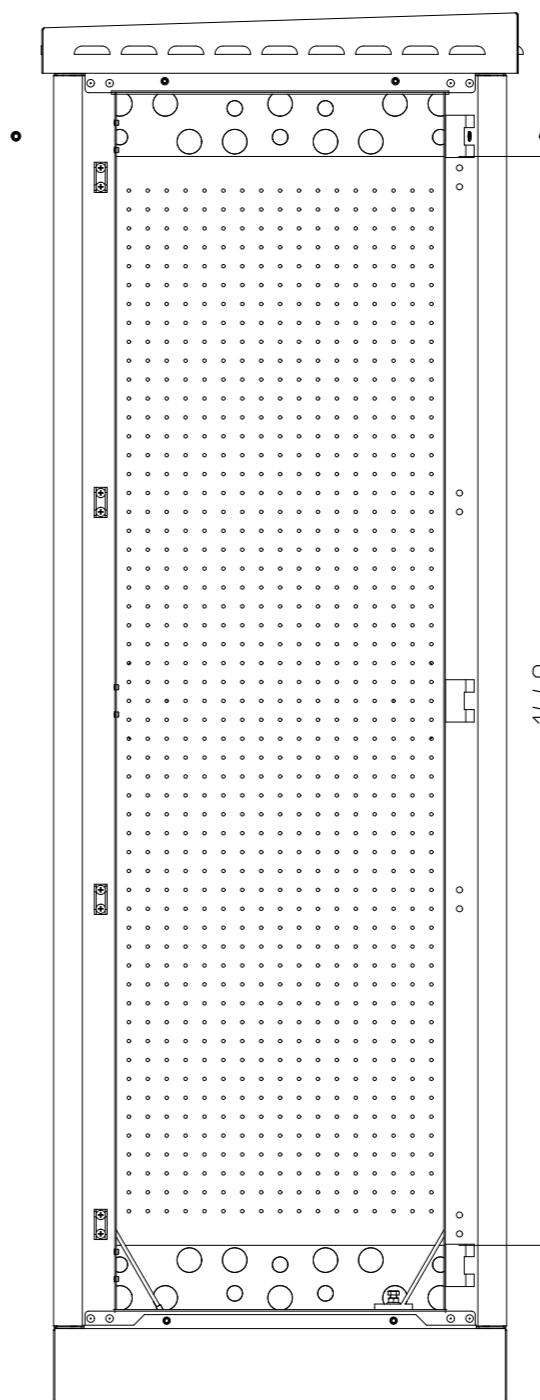
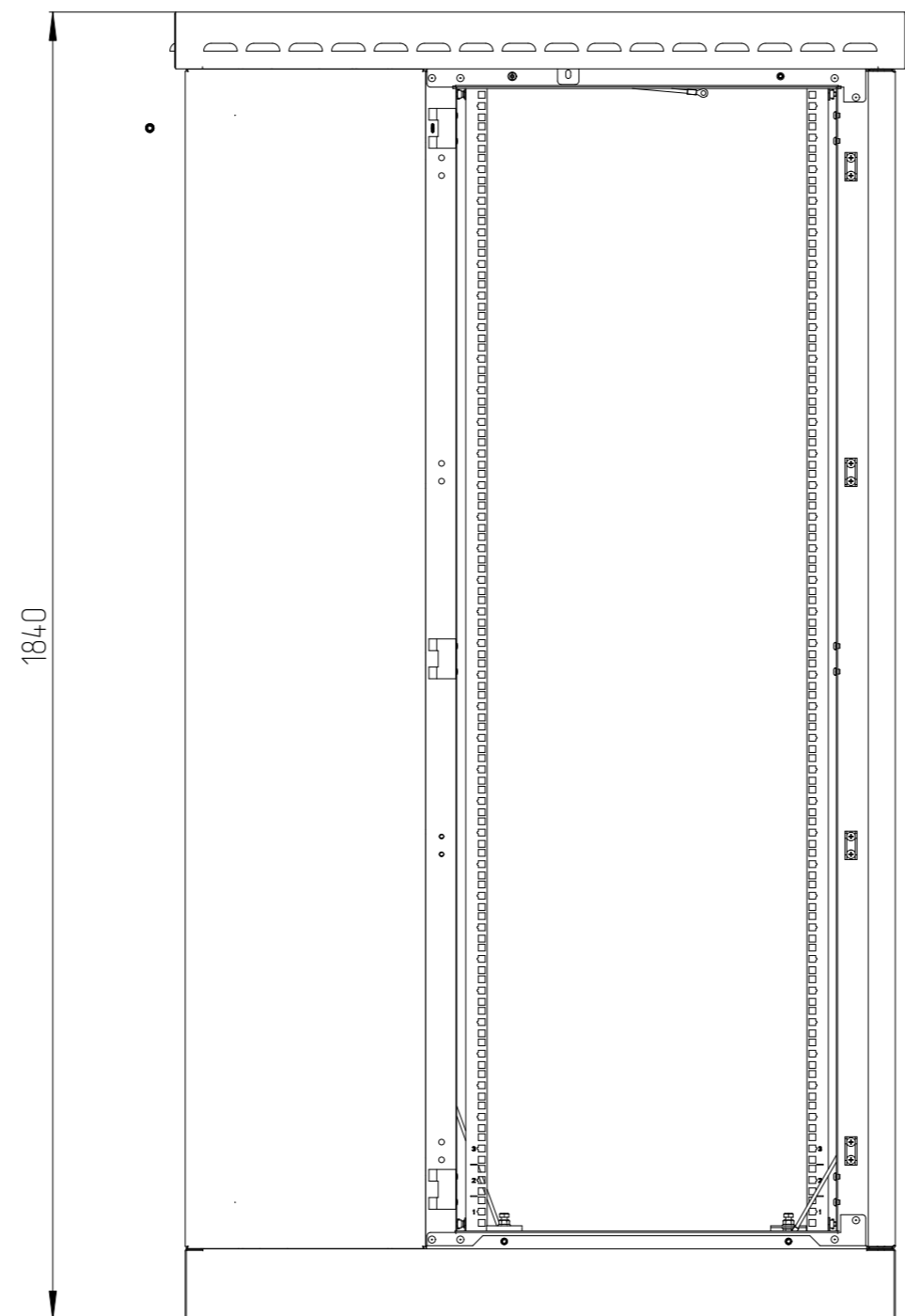

Электроотсек в разрезе

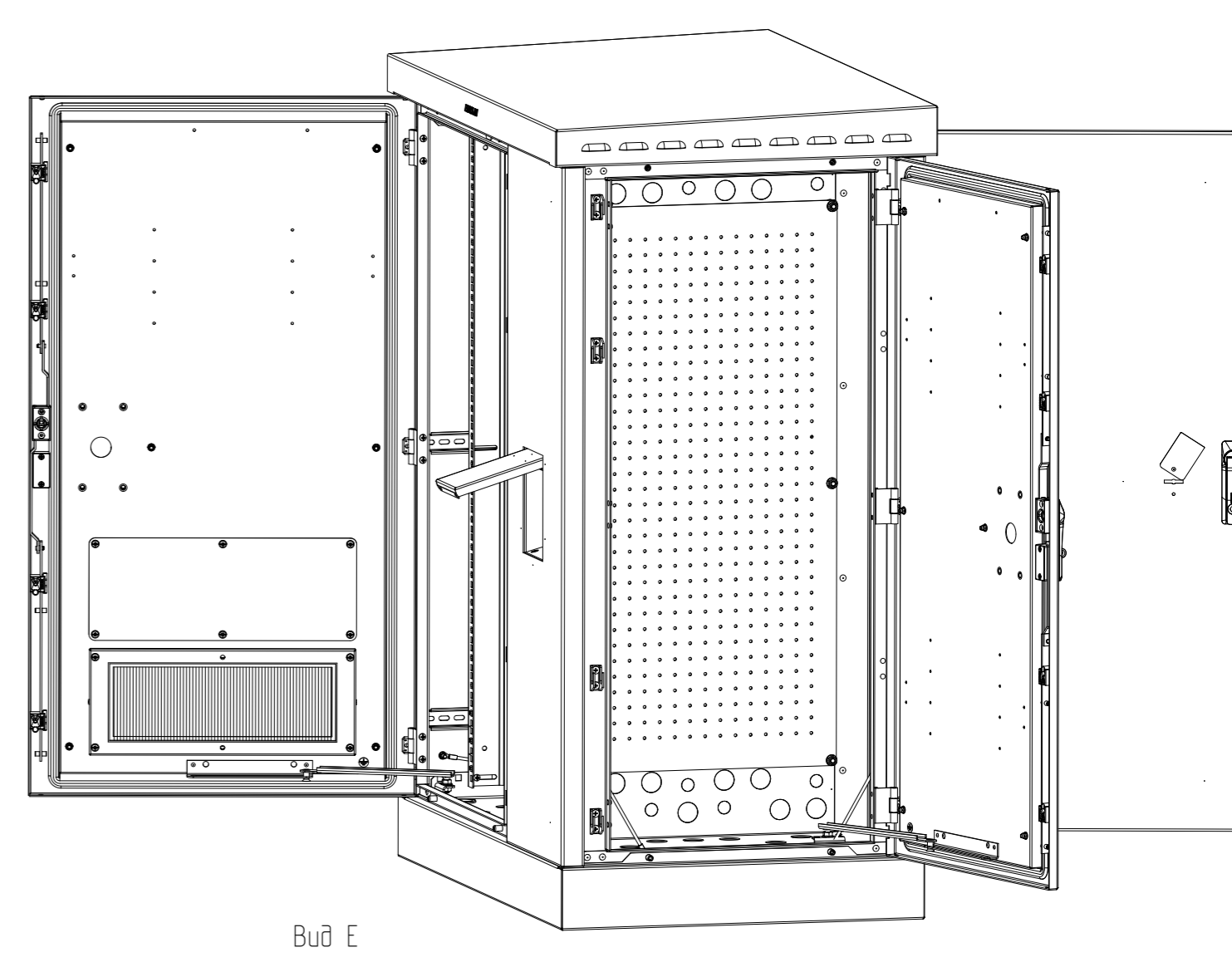
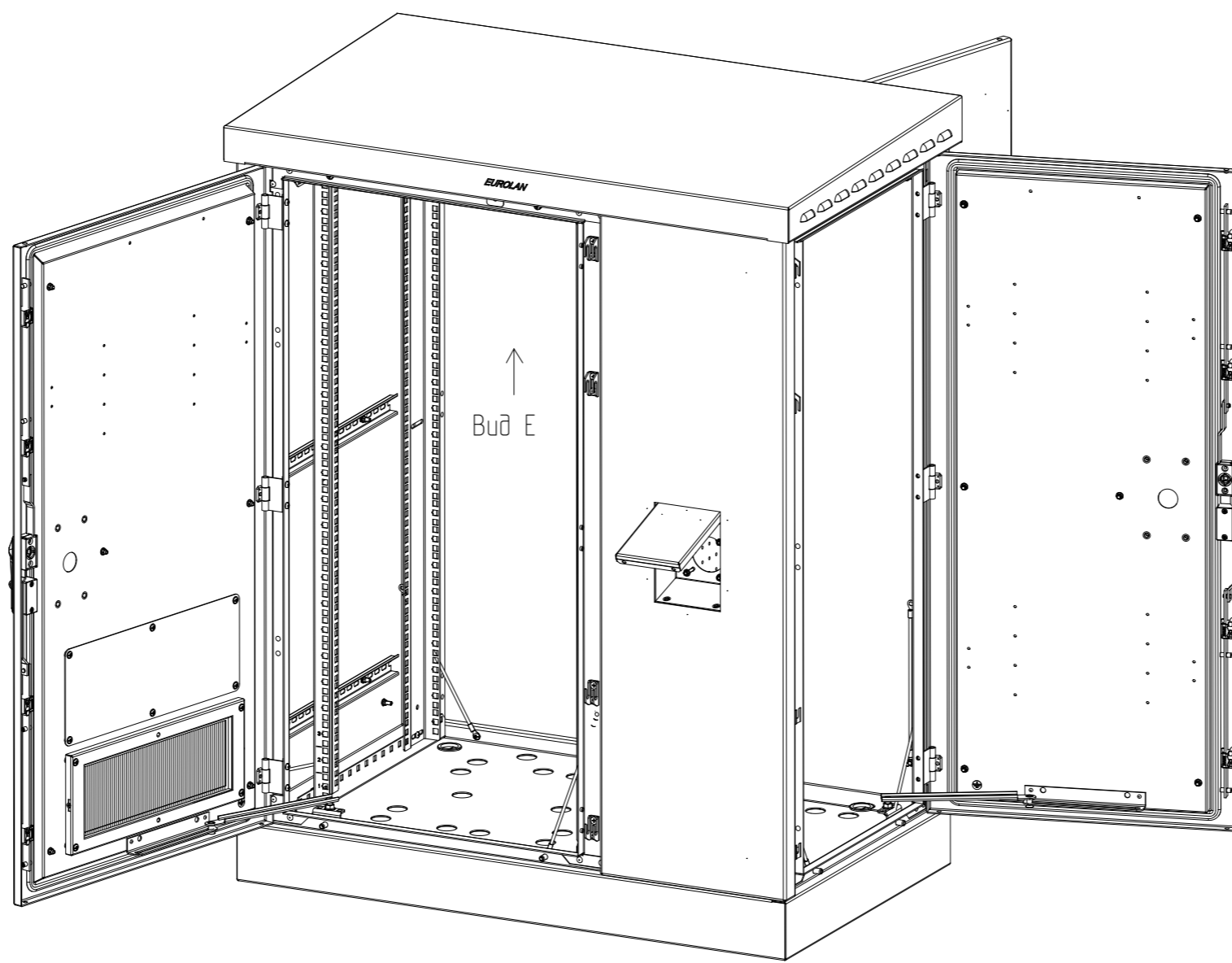
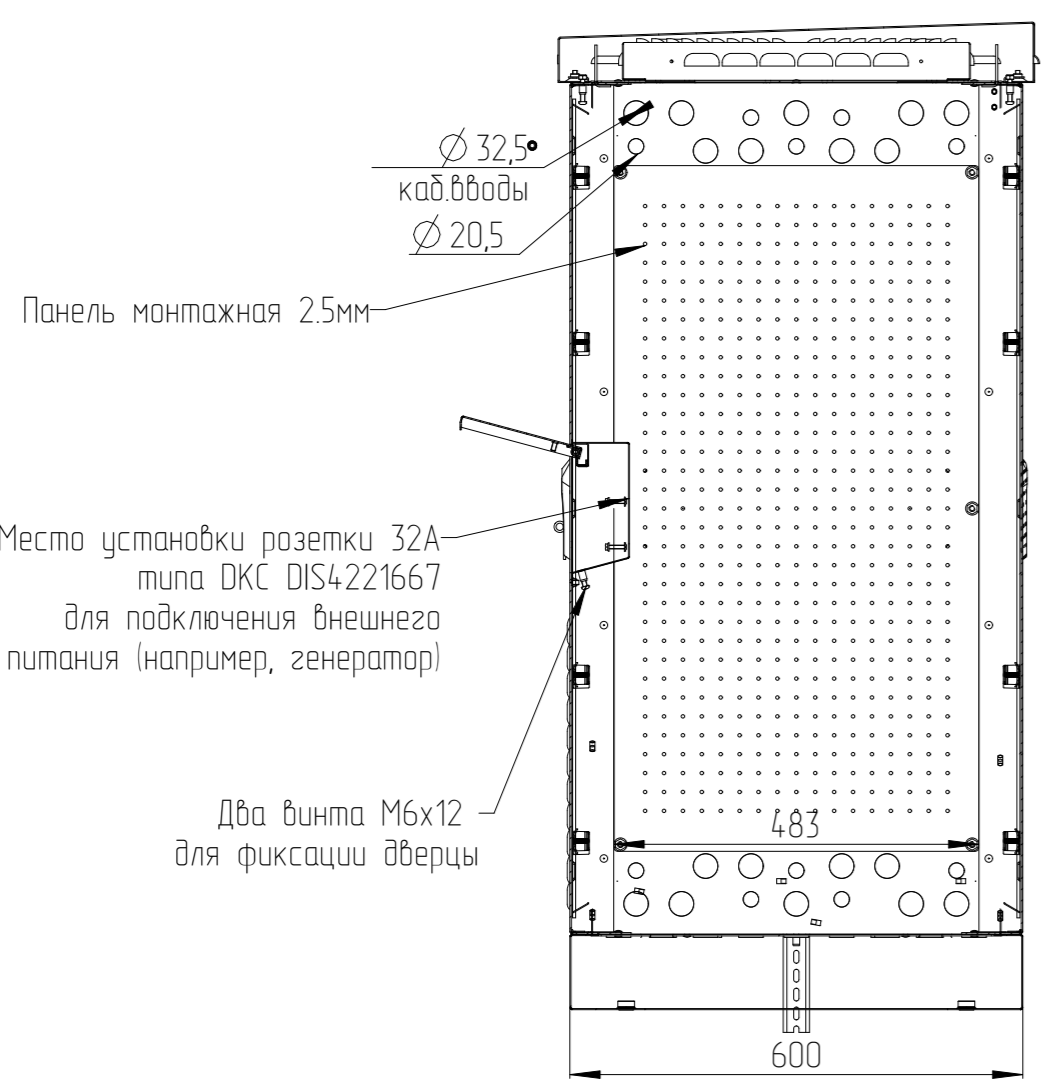

Цоколь базовый (высотой 100мм)

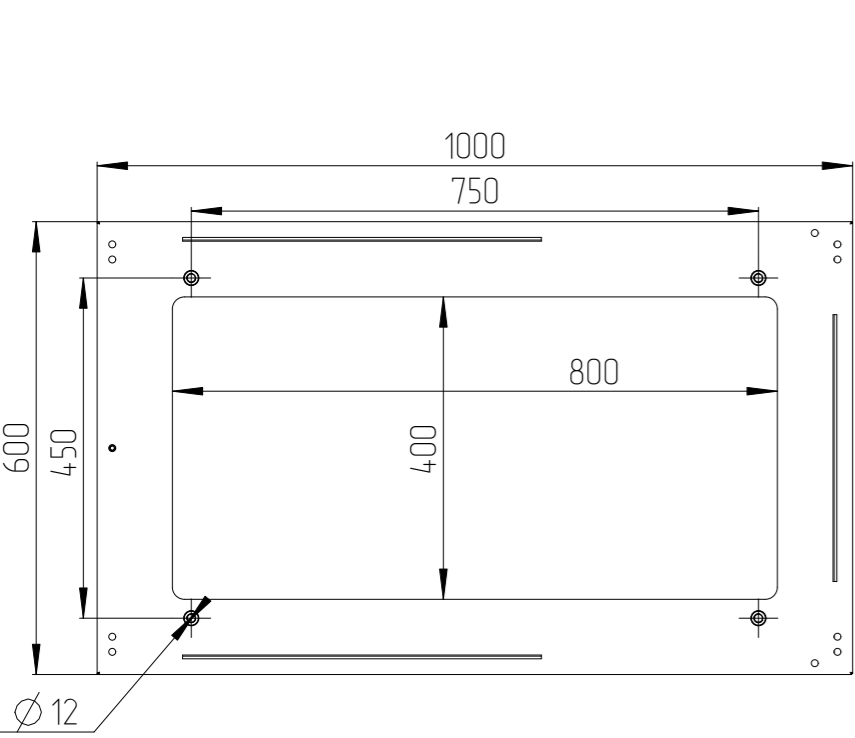

Сечение шкафа, каб. вводы

В-В
1:10

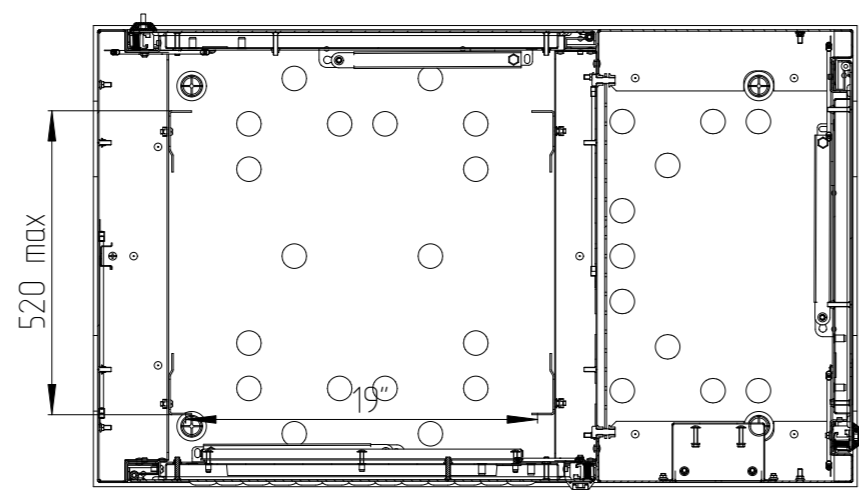

Вид снизу и габариты по крыше

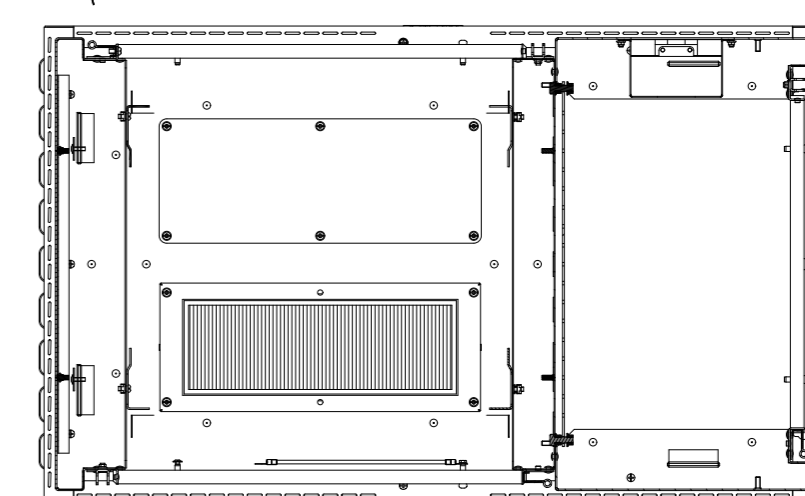
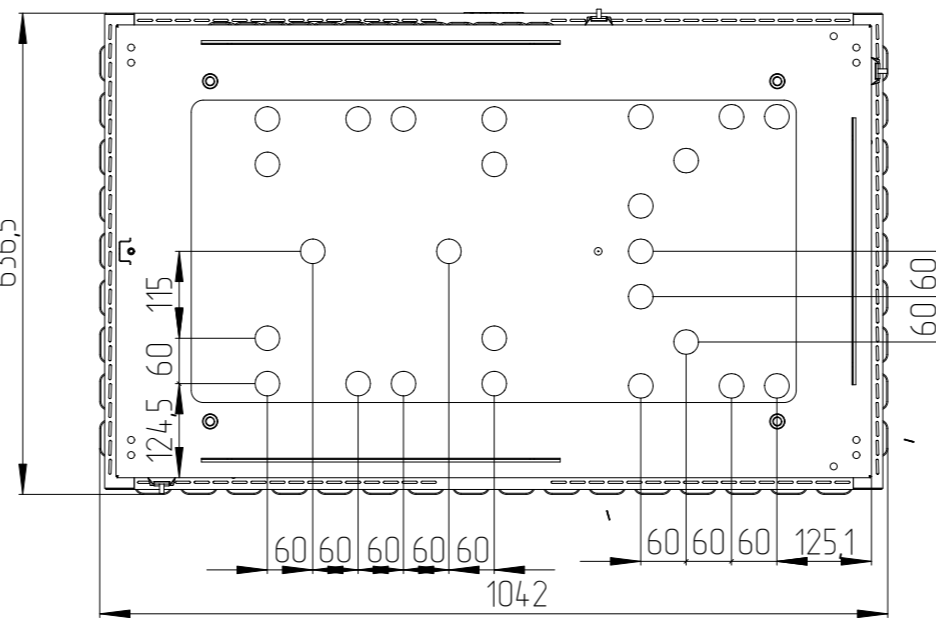

Имя и дата	Подп. и дата	Взам. инв. №	Иное № дубл.	Подп. и дата	Справ. №	Перв. примен.
------------	--------------	--------------	--------------	--------------	----------	---------------

Имя файла модели						
Имя файла чертежа						
Изм.	Лист	№ докум.	Подп.	Дата		
Разраб.						
Пров.						
Т.контр.						
Н.контр.						
Утв.						
60F-24-A6-65GY				Лит.	Масса	Масштаб
60F-30-A6-65GY						1:10
60F-36-A6-65GY				Лист 1	Листов 1	