

Перв. примен.

Справ. N

Подп. и дата

Подп. и дата

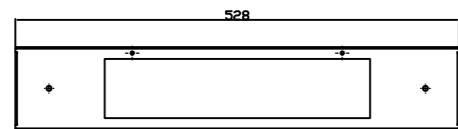

FRONT VIEW



SIDE VIEW



TOP VIEW

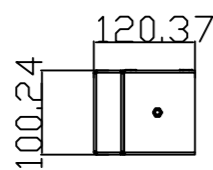
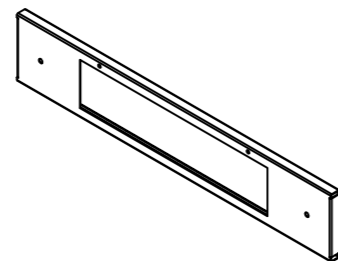

FRONT VIEW

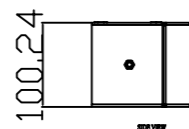

SIDE VIEW

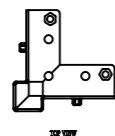

TOP VIEW

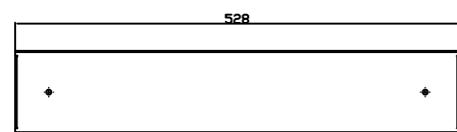

FRONT VIEW



SIDE VIEW



TOP VIEW

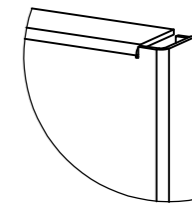
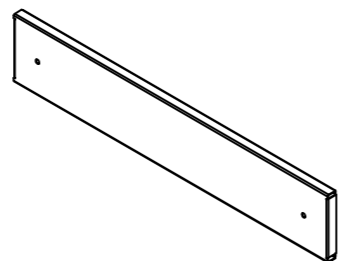

SCALE 2:1  
DETAIL A

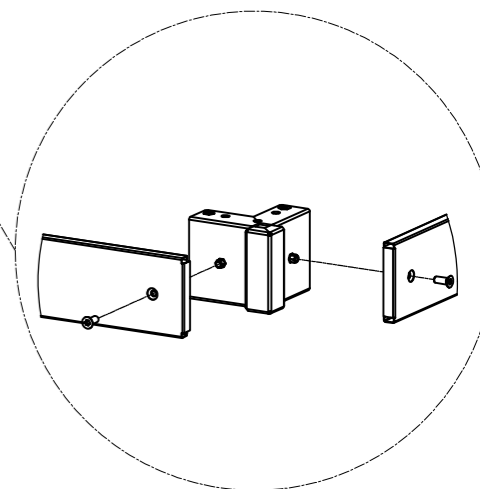
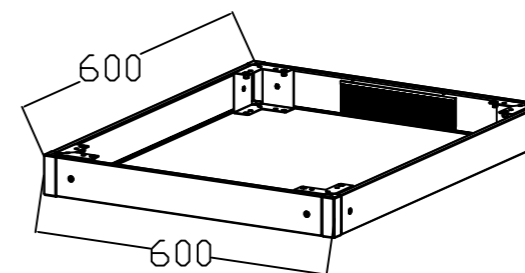
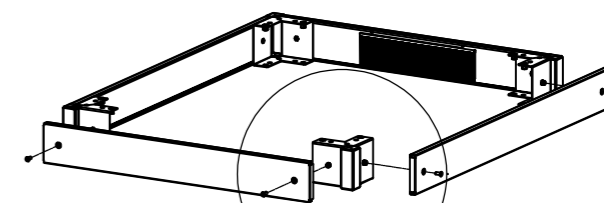
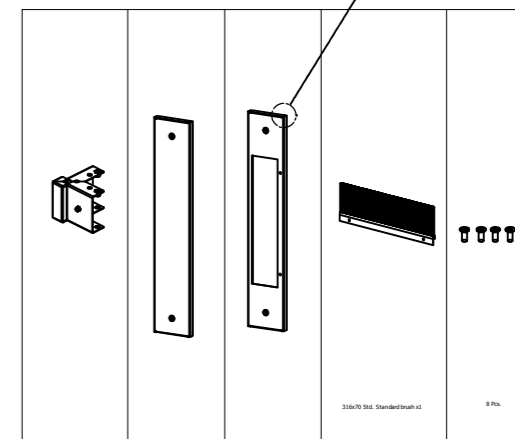

Изм.	Лист	N докум.	-	Дата	60A-07-66-21BL	0				
Разраб.										
Проб.										
Т.контр.										
Н.контр.										
Утв.										

Лист 1 / Листов 4



Копировал:

Формат А3